



The addition of a spirit level is a matter of course, thanks to which your measurement in both planes will be very accurate and fun.

Cloned antenna series are available through **AU Technology**, which guarantees constant parameters.

Features and Specifications



Technical Performance

- Wide bandwidth
- Low return loss
- Individual calibration



Design and Surface Treatment

- Corrosion-resistant coating
- Includes standard mount
- Very precise spirit level



Manufacturing Technology

- Manufactured using a high grade aluminum alloy
- Extremely durable
- High quality SMA type coaxial connector



Product Packaging Includes

- Adapter with ¼ inch inner thread, supplied with antenna
- Linear polarized double ridged broadband horn antenna

Product Parameters

PRODUCT IDENTIFICATION

Product Name	DRH20E
Product Category	Double Ridged Horn Antenna

ELECTRICAL SPECIFICATIONS

Frequency Range	1.6 GHz – 20 GHz
VSWR (max.)	1.5
VSWR (avg.)	1.2
Impedance	50 Ohm
Connector	SMA (female)
Power (CW / Peak)	50 W / 100 W
Antenna Factor	29 – 40.5 dB/m
Polarization	Linear

PHYSICAL SPECIFICATIONS

Width	103.8 mm (4.087 in)
Height	122.7 mm (4.831 in)
Depth	78.7 mm (3.098 in)
Weight	0.32 kg (0.705 lb)

OPERATING CONDITIONS

Rated Temperature Range	0°C – +50°C
Storage Temperature Range	-20°C – +70°C

MOUNTING FLANGE

Mounting	Adapter with ¼ inch inner thread, supplied with antenna
----------	--

Mechanical Drawings

Antenna

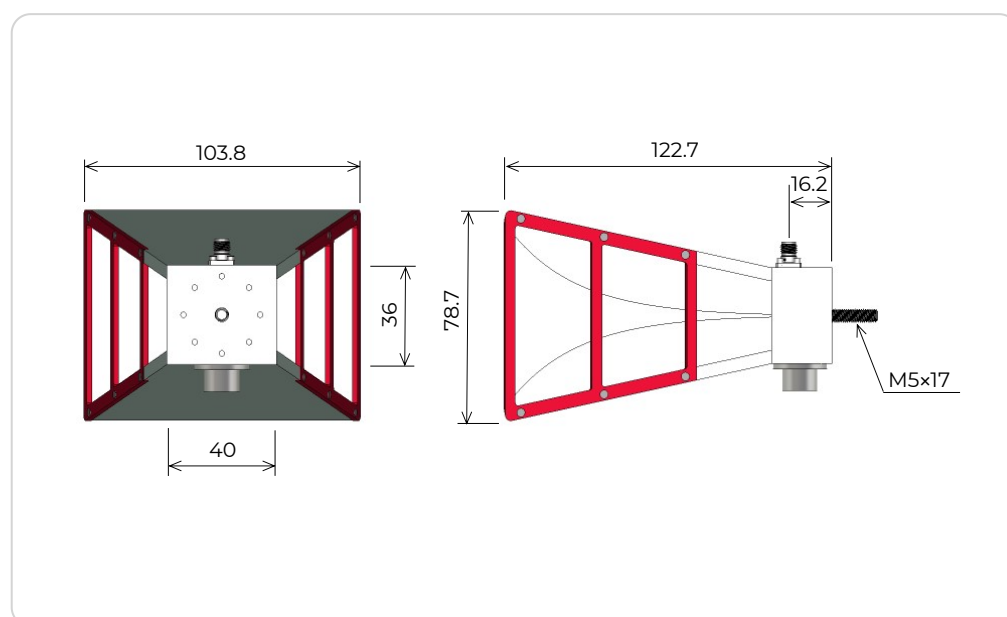

Mounting flange

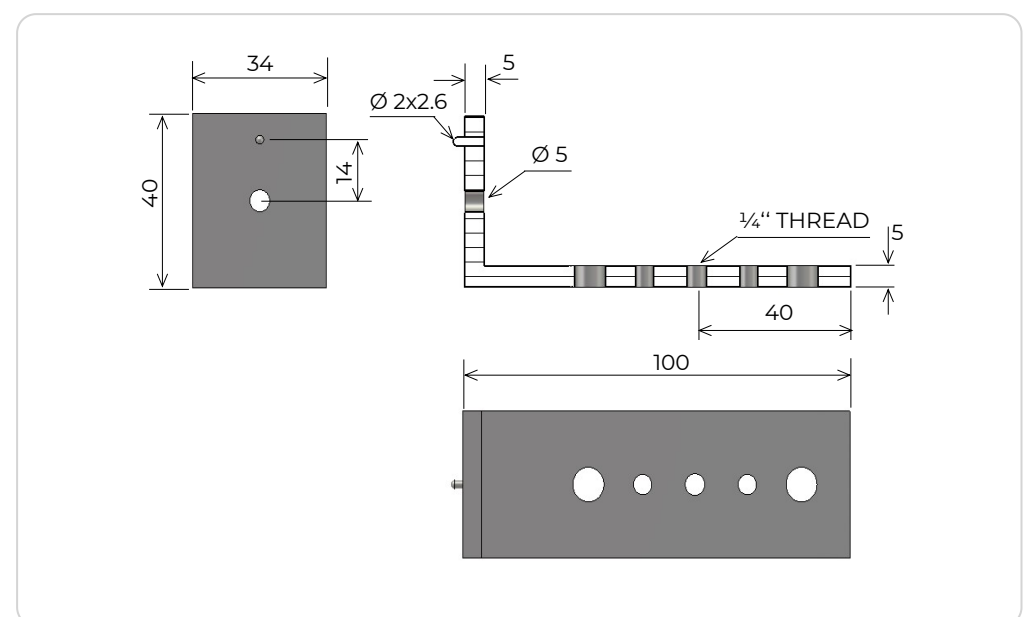

Parameters and Performance

Typical parameters

VSWR

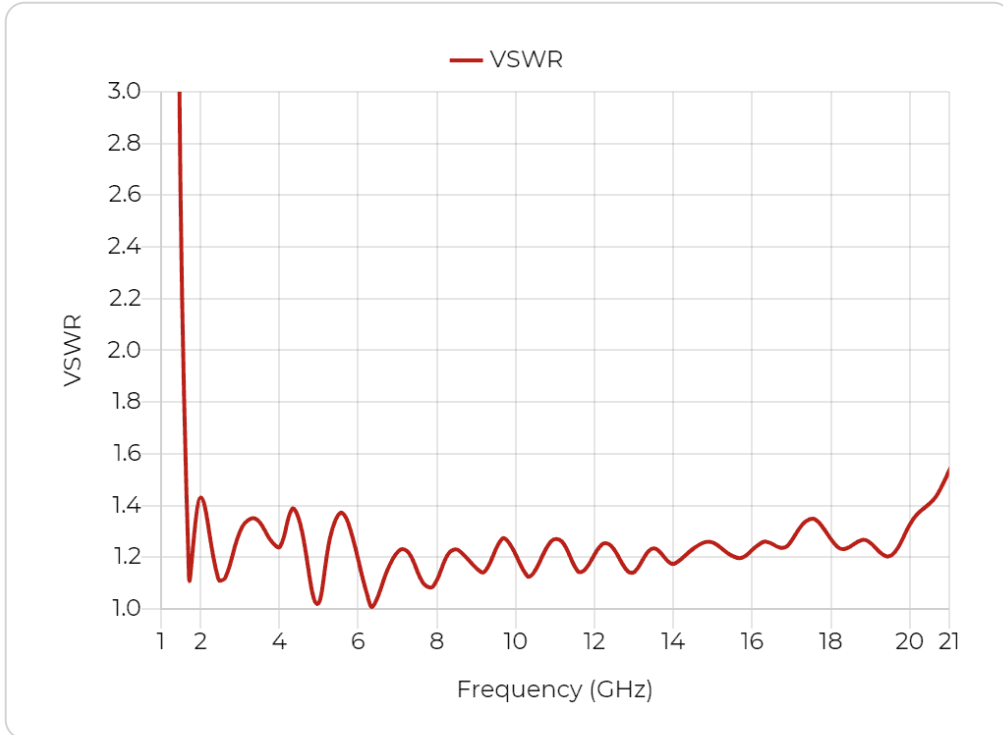

Gain

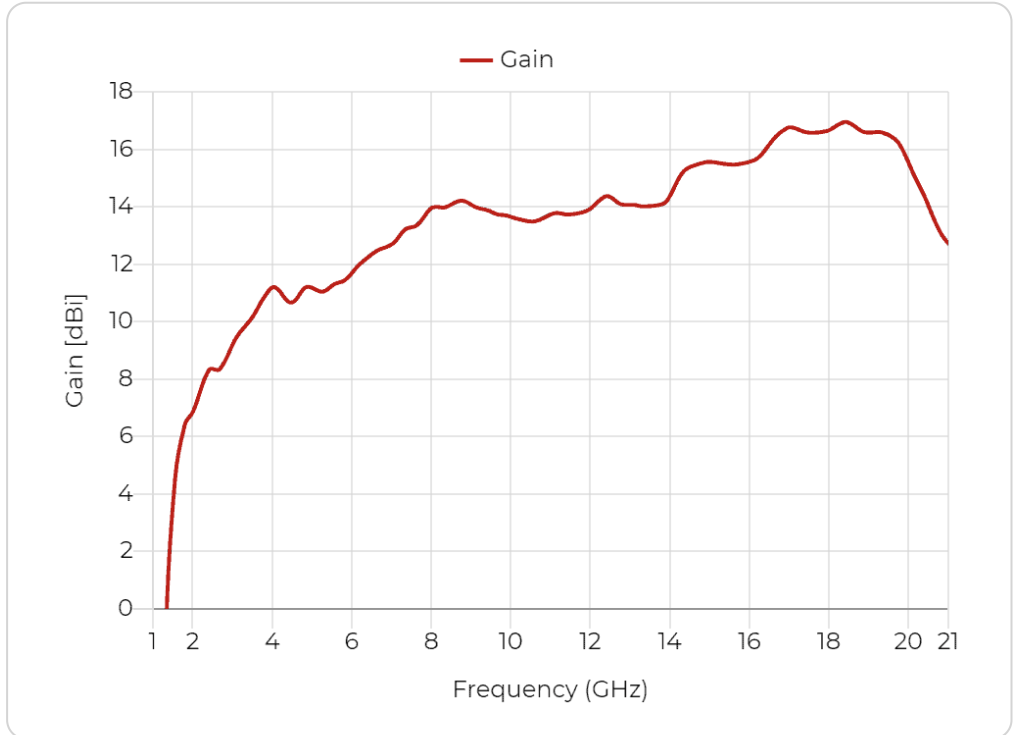

Antenna Factor

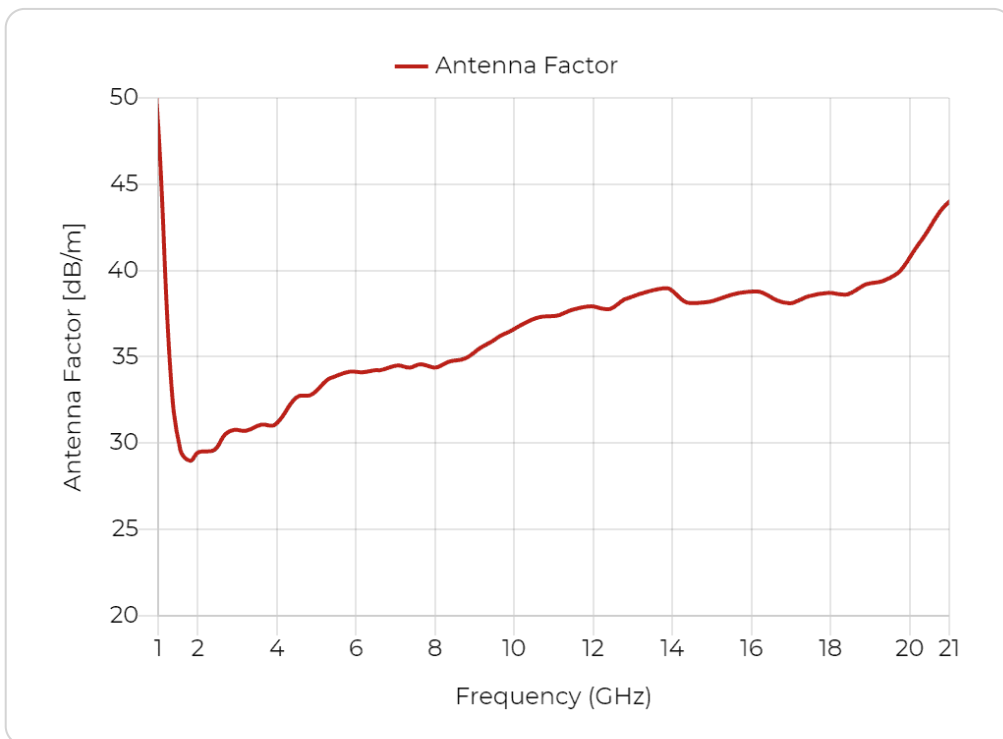

Cross Polarization

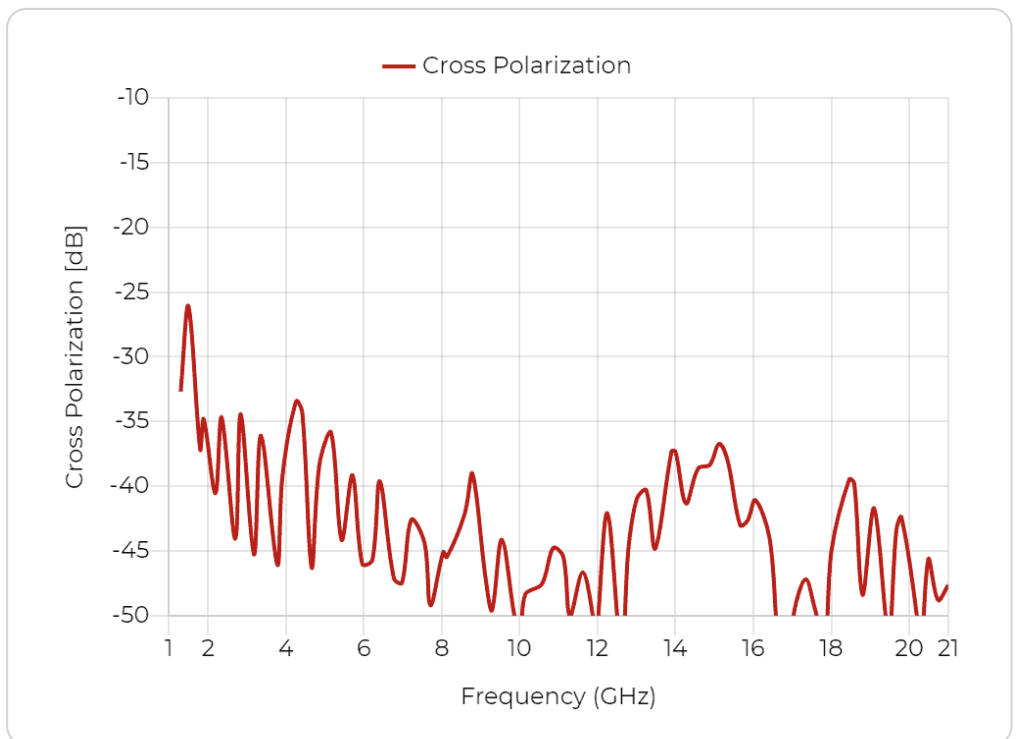

Beamwidth

Port A, E plane

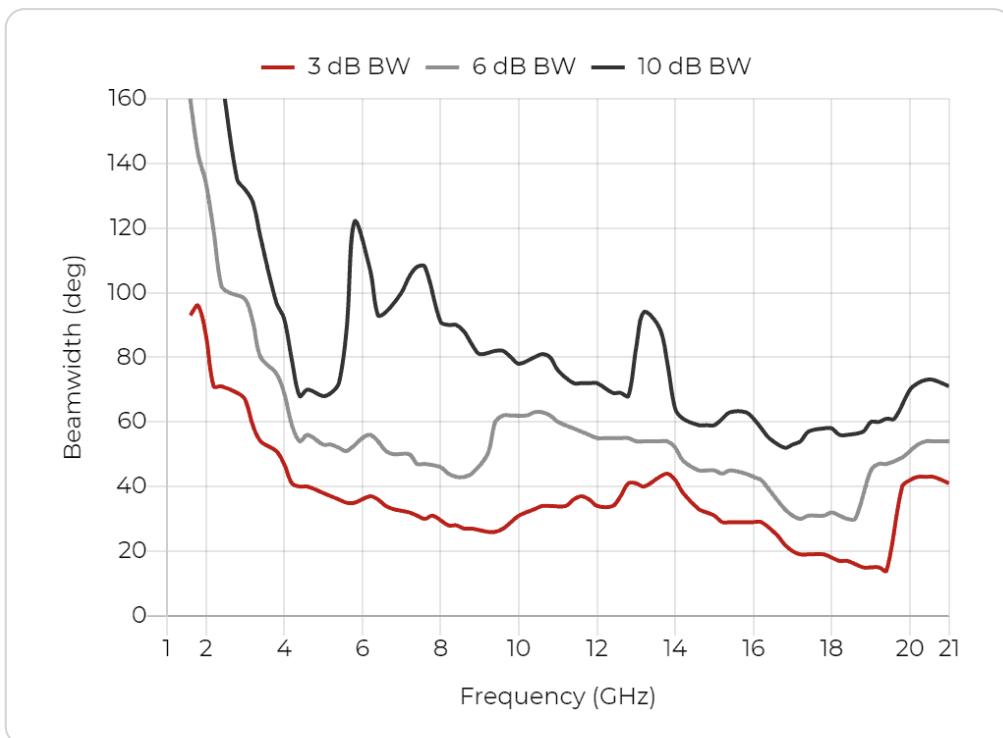

Port A, H plane

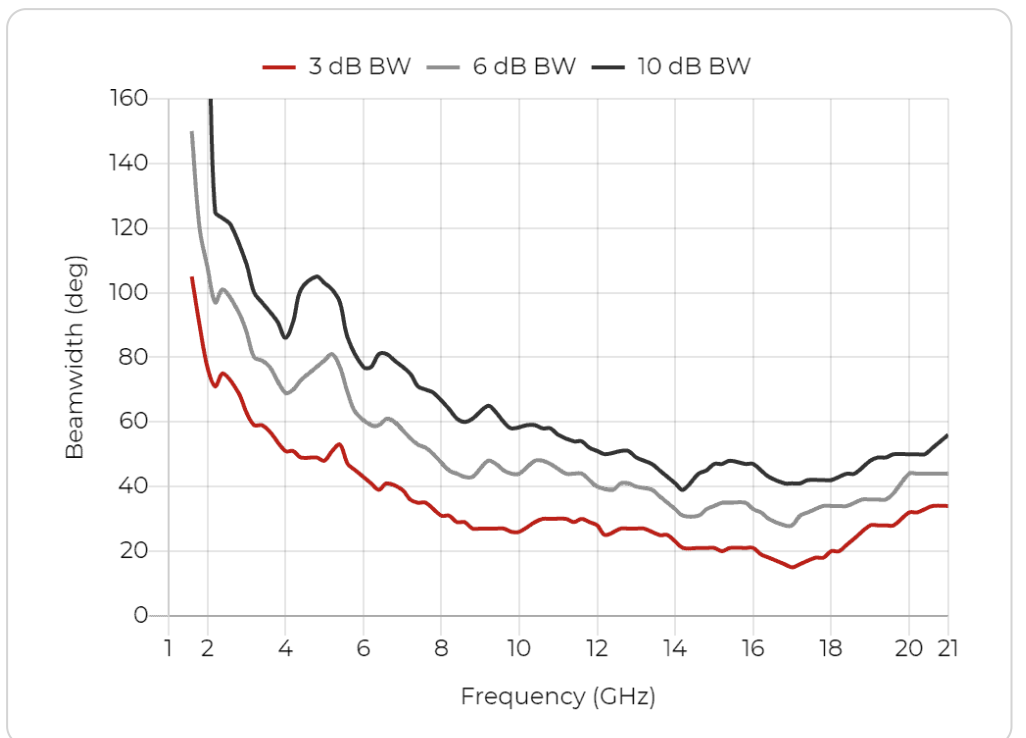

Radiation Patterns

1.6 GHz

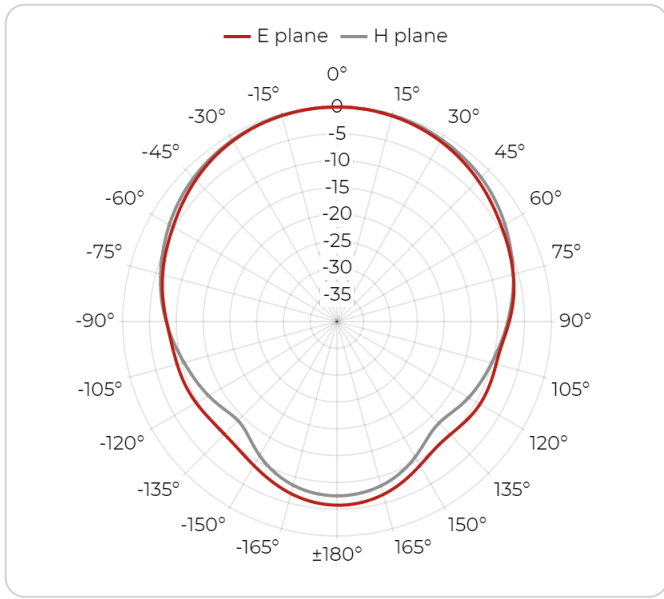

2 GHz

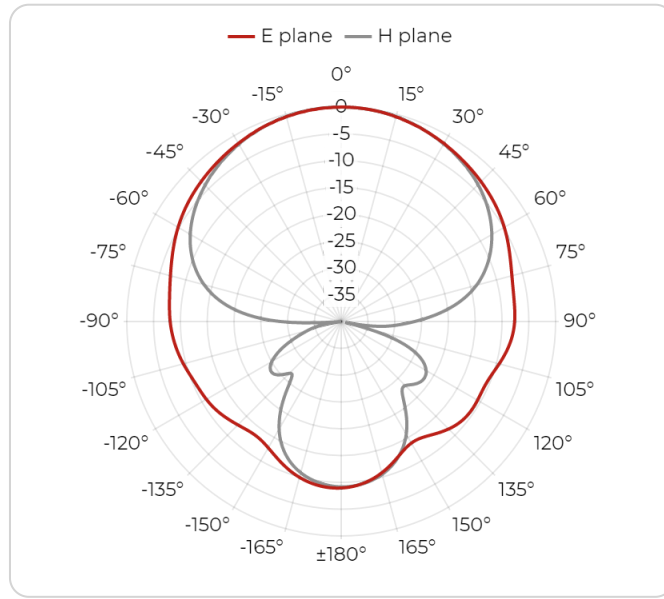

3 GHz

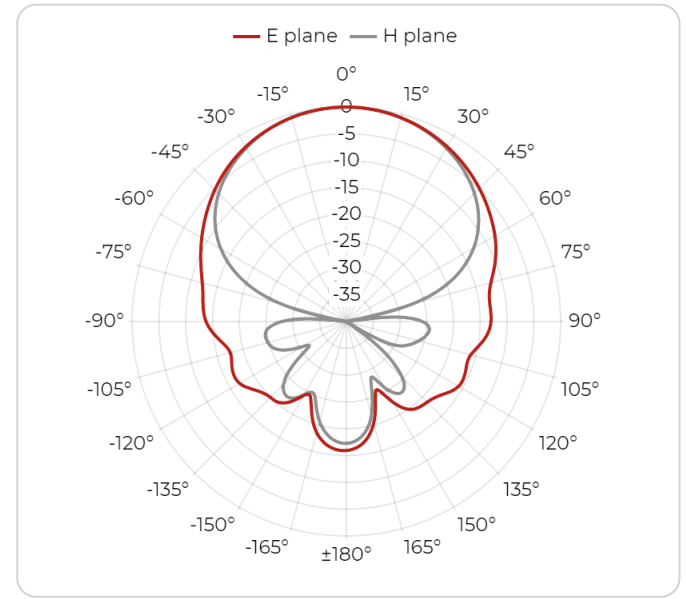

4 GHz

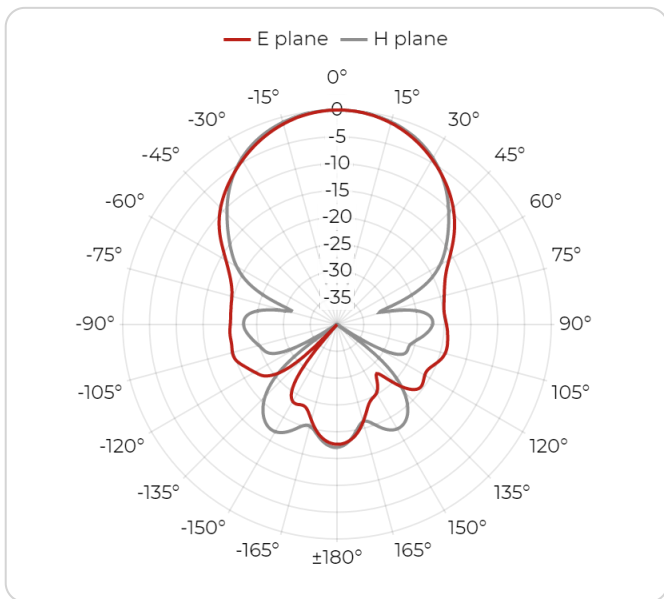

6 GHz

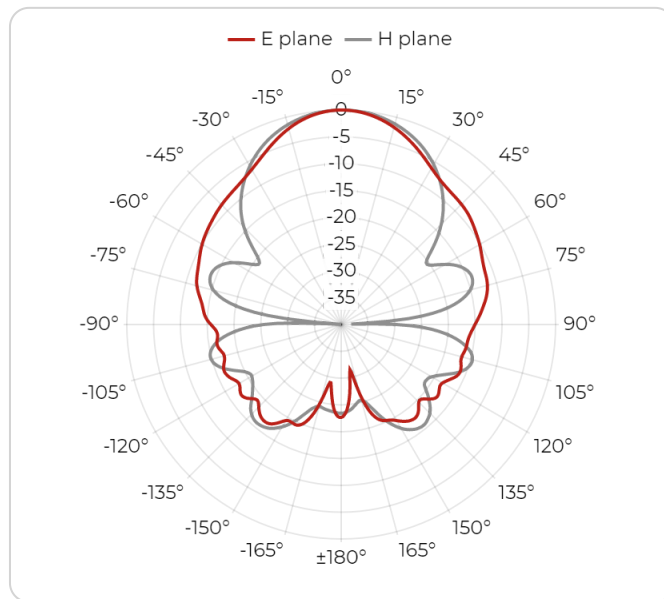

8 GHz

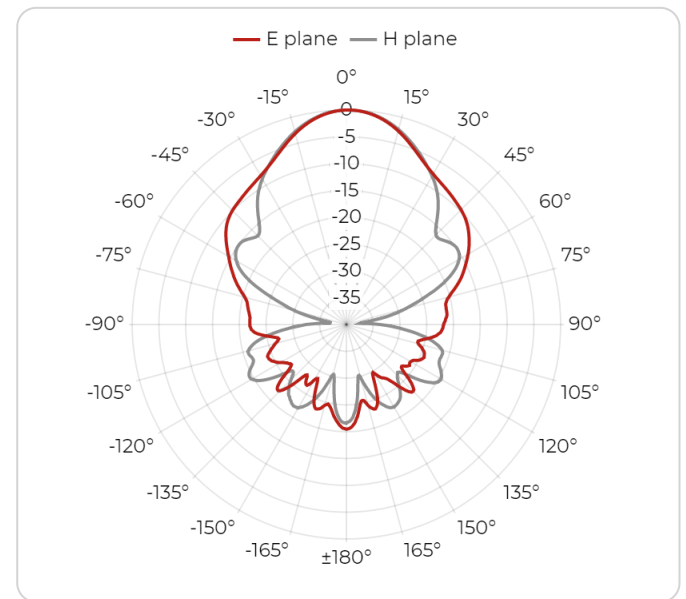

10 GHz

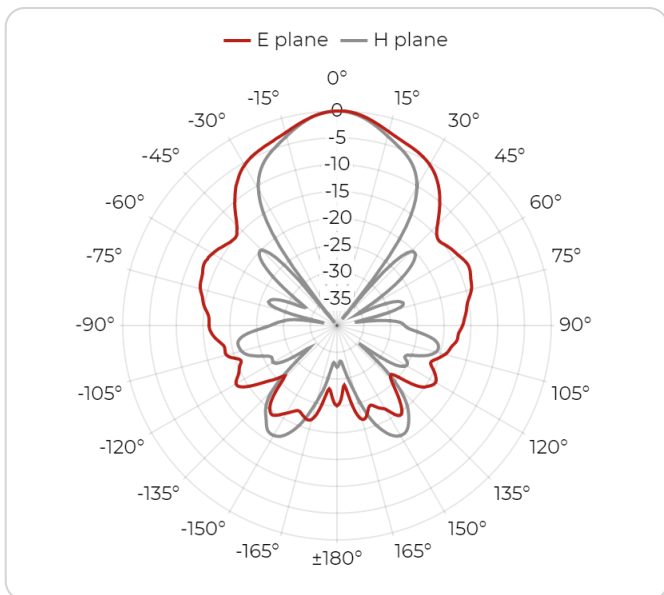

12 GHz

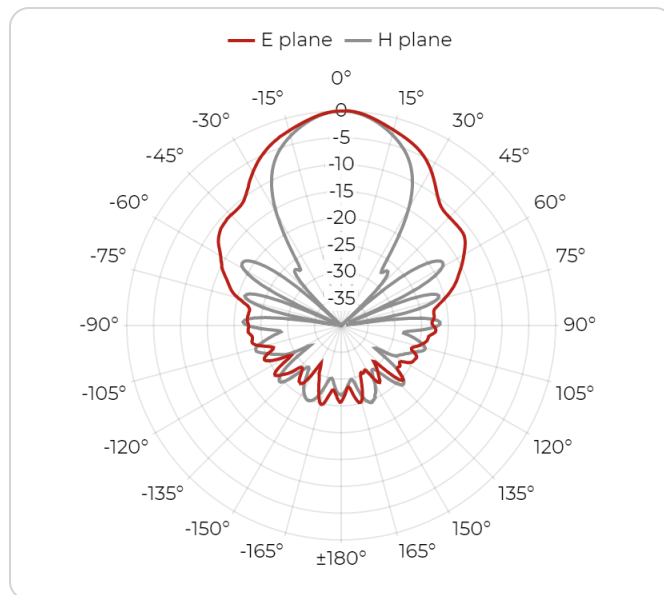

14 GHz

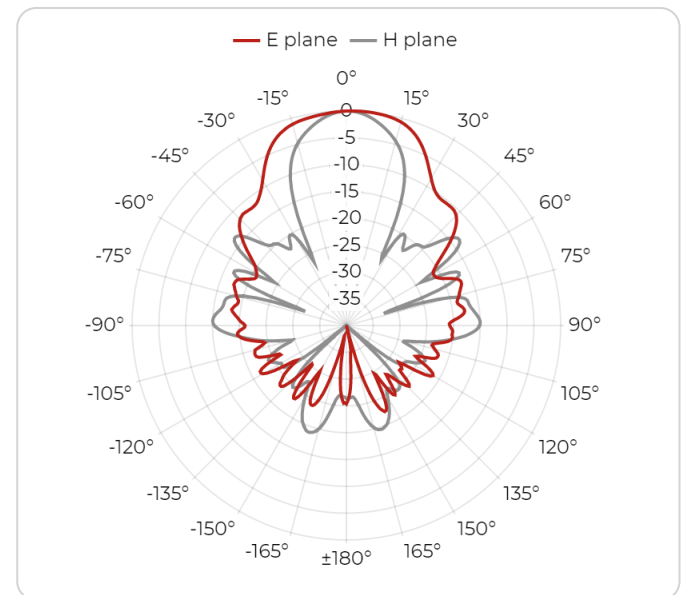

16 GHz

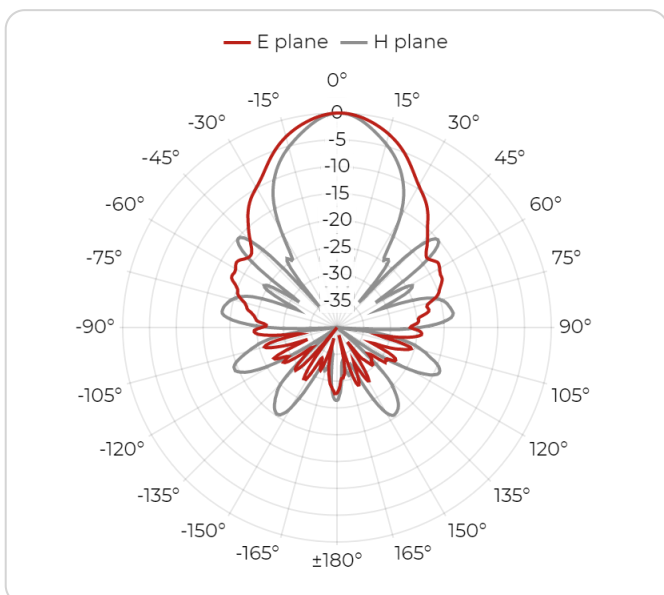

18 GHz

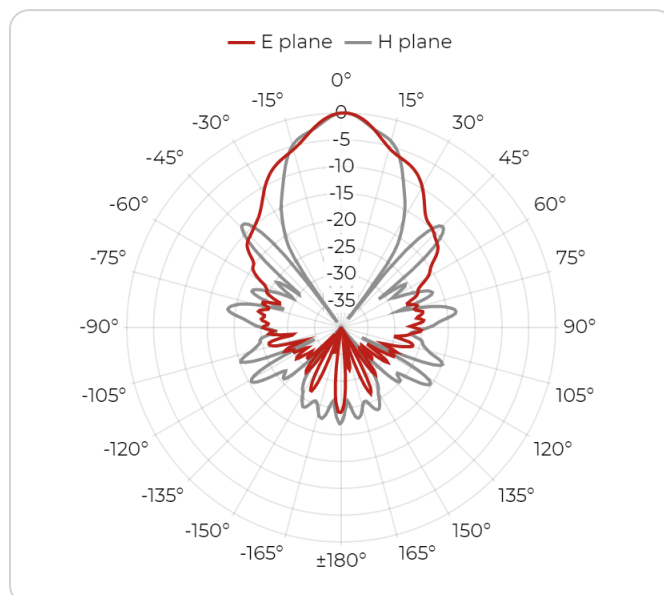

20 GHz

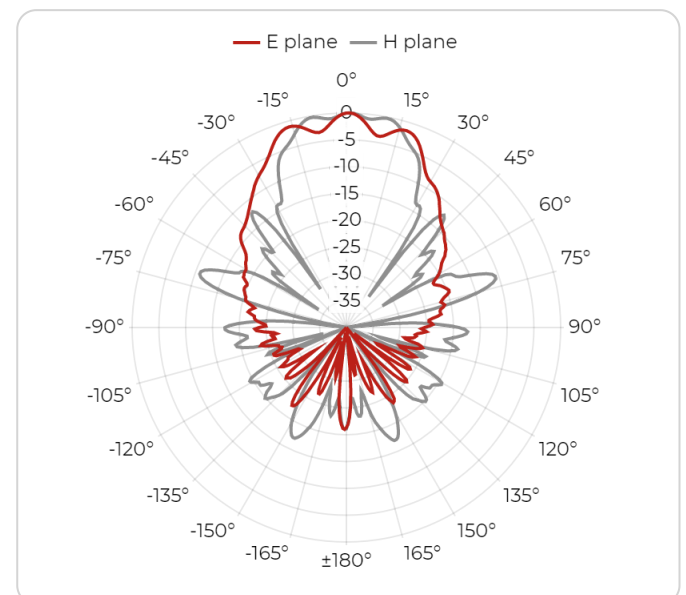

Packaging and Accessories

Optional Accessories

- [AHS22-HI Antenna Fixture](#)
- [PAS02 Antenna Stand](#)
- [PAS2022 Antenna Stand](#)

Custom services

- Custom mounting solutions
- Custom calibration data

What's in a box

- DRH20E Antenna
- Antenna specific mount adapter with ¼ inch inner thread

Accessories

- Standard mounting flange

Manufacturer Information

About Datasheet

Product information available also online at
<https://www.rfspin.com/product/drh20e/>

Data and specifications subject to change without notice.

Datasheet revision 02-2024.

© RFspin 2024

📍 Address

RFspin s.r.o.
Na Beránce 57/2
160 00 Prague 6
Czech Republic

✉ E-mail

info@rfspin.com

📞 Phone

[+420 245 008 847](tel:+420245008847)