

DRH0844 is a broadband horn antenna with K connector covering frequency band 8 GHz – 44 GHz. This antenna goes up to the limit, with a high Gain of 20dB.

Cloned antenna series are available through **AU Technology**, which guarantees constant parameters.

Manufactured with RF SPIN's **SPM Technology** to achieve the best mechanical and radio parameters.

## Features and Specifications



### Technical Performance

- Wide bandwidth
- Low return loss
- Individual calibration
- Covers 5G frequency band



### Design and Surface Treatment

- Corrosion-resistant coating
- Includes standard mount



### Manufacturing Technology

- High quality 2.92mm type coaxial connector
- Extremely durable



### Product Packaging Includes

- Antenna
- Adapter with ¼ inch inner thread, supplied with antenna
- Linear polarized double ridged broadband horn antenna

## Product Parameters

### PRODUCT IDENTIFICATION

Product Name	<b>DRH0844</b>
Product Category	<b>Double Ridged Horn Antenna</b>

### ELECTRICAL SPECIFICATIONS

Frequency Range	<b>8 GHz – 44 GHz</b>
VSWR (max.)	<b>2</b>
VSWR (avg.)	<b>1.3</b>
Impedance	<b>50 Ohm</b>
Connector	<b>K (female)</b>
Power (CW / Peak)	<b>15 W / 30 W</b>
Antenna Factor	<b>32 – 40 dB/m</b>
Polarization	<b>Linear</b>

### PHYSICAL SPECIFICATIONS

Width	<b>87 mm (3.425 in)</b>
Height	<b>63 mm (2.480 in)</b>
Depth	<b>220 mm (8.661 in)</b>
Weight	<b>0.512 kg (1.129 lb)</b>

### OPERATING CONDITIONS

Rated Temperature Range	<b>0°C – +50°C</b>
Storage Temperature Range	<b>-20°C – +70°C</b>

### MOUNTING FLANGE

Mounting	<b>Adapter with ¼ inch inner thread, supplied with antenna</b>
----------	--

## Mechanical Drawings

Antenna

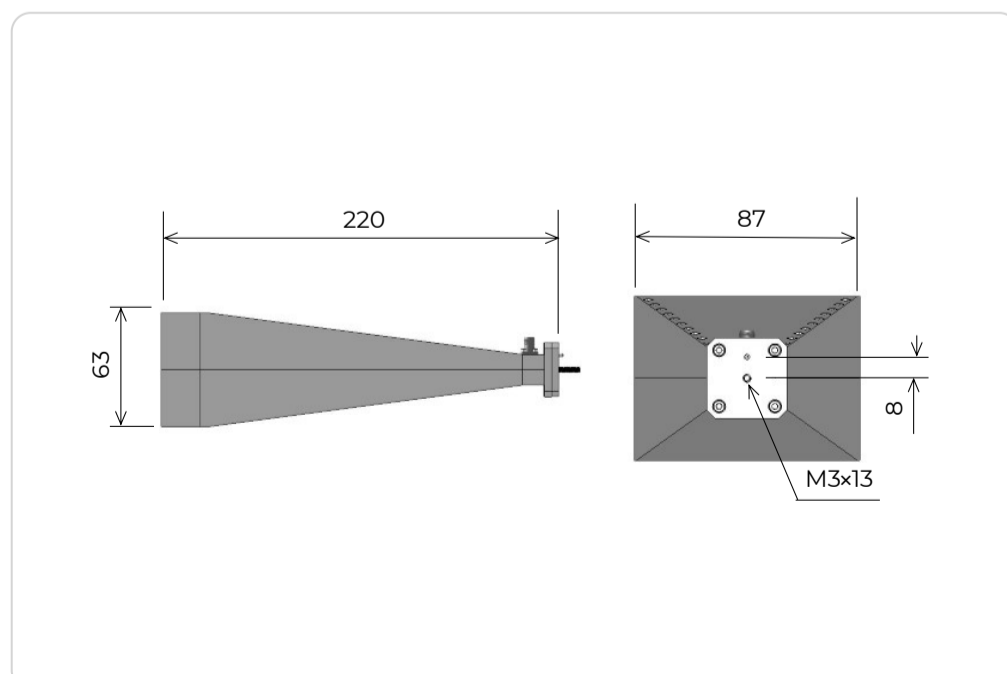

Mounting flange

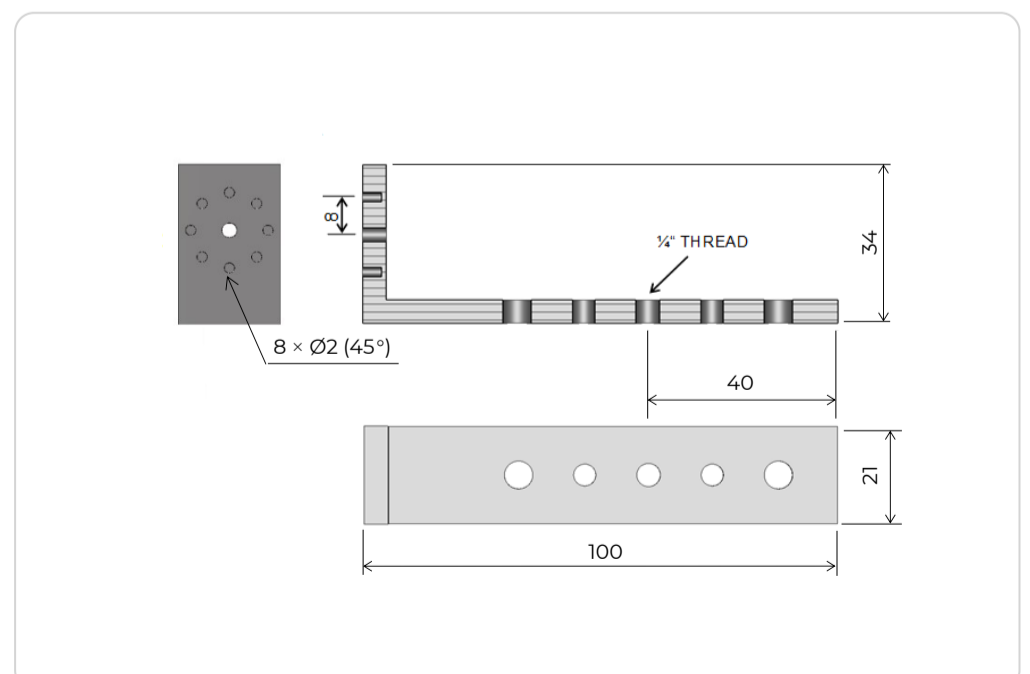

# Parameters and Performance

## Typical parameters

VSWR

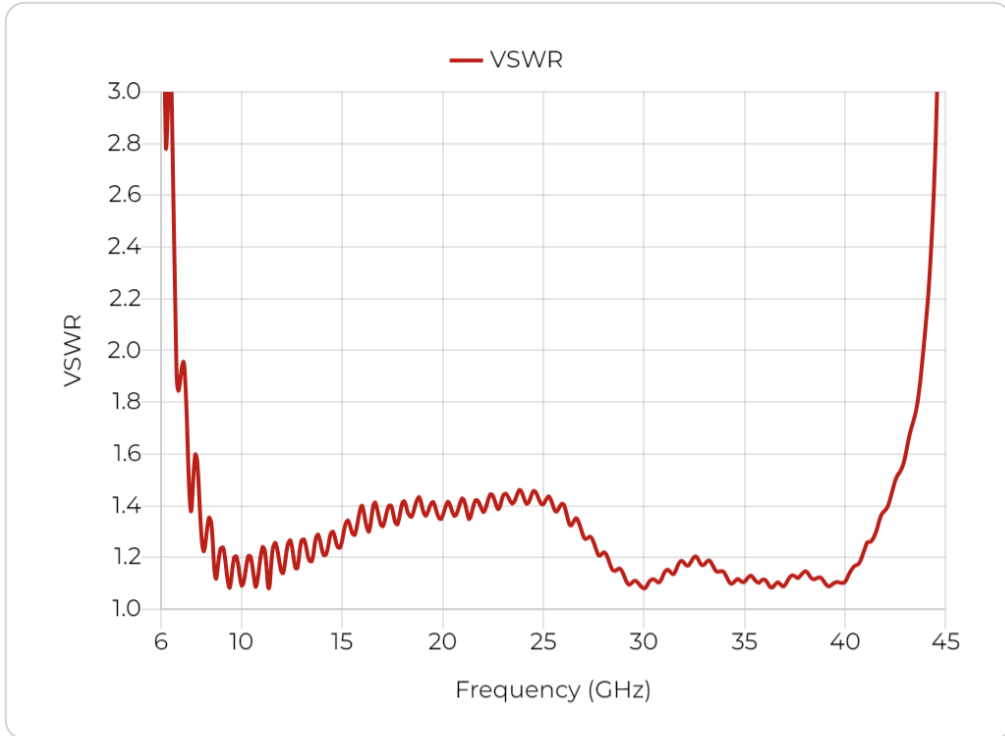

Gain

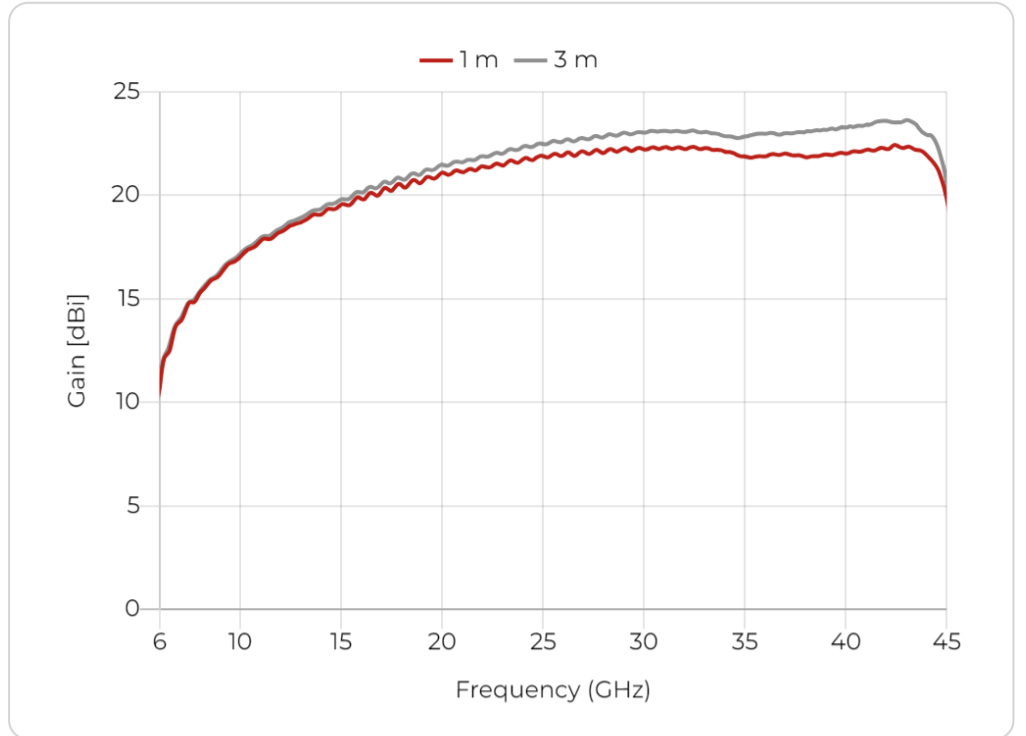

Antenna Factor

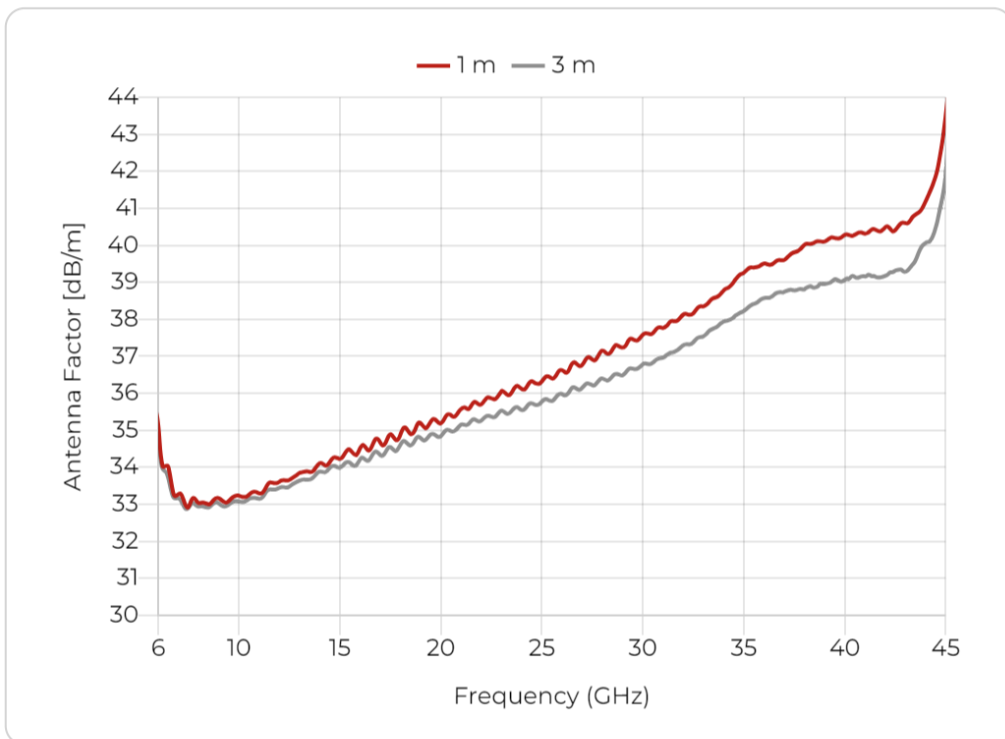

Cross Polarization

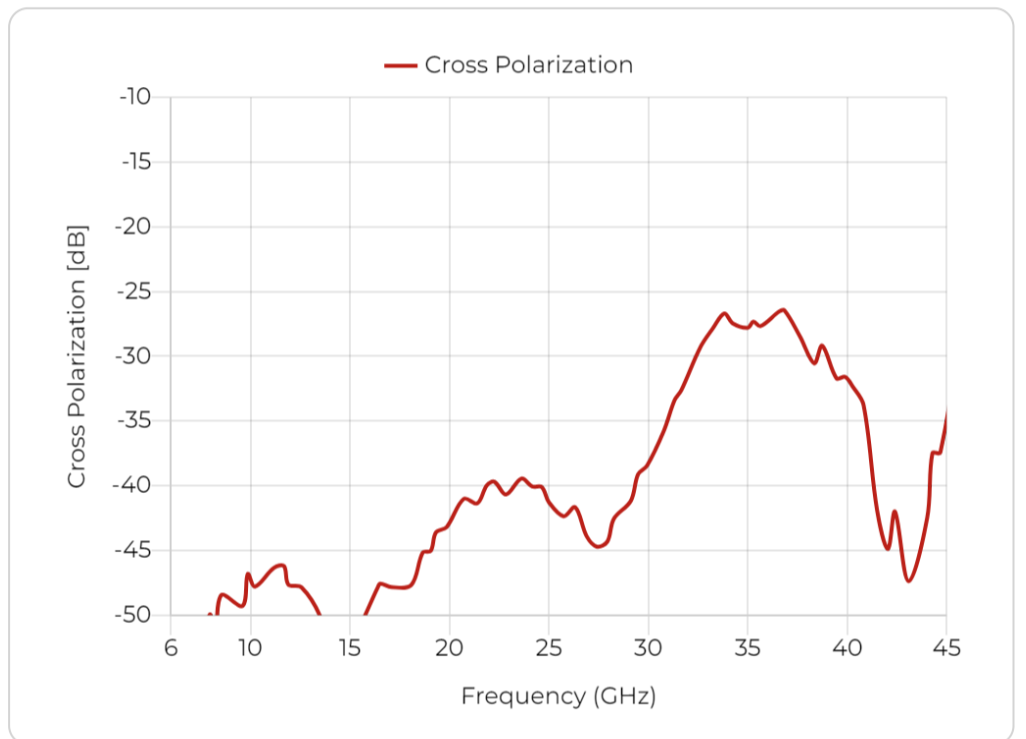

## Beamwidth

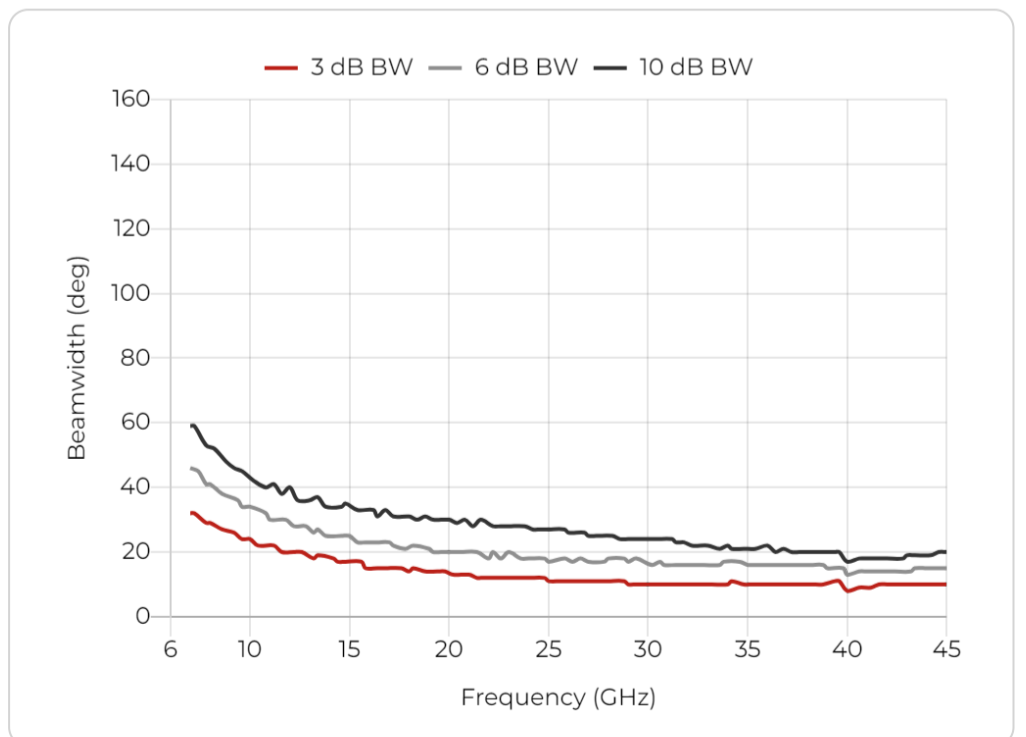
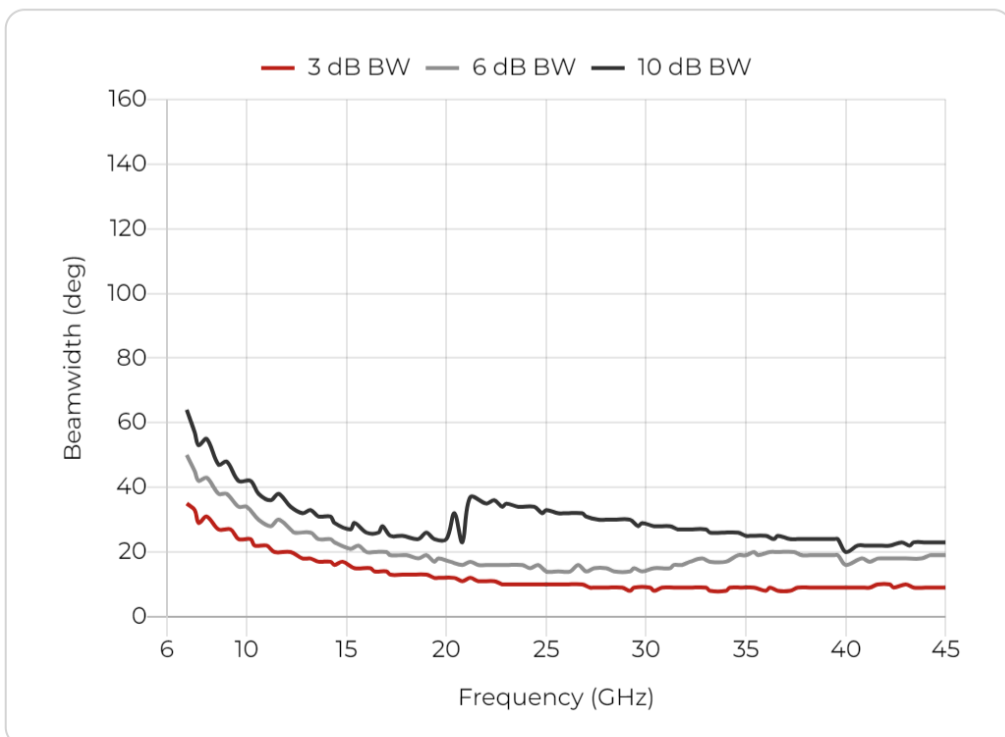

# Radiation Patterns

8 GHz

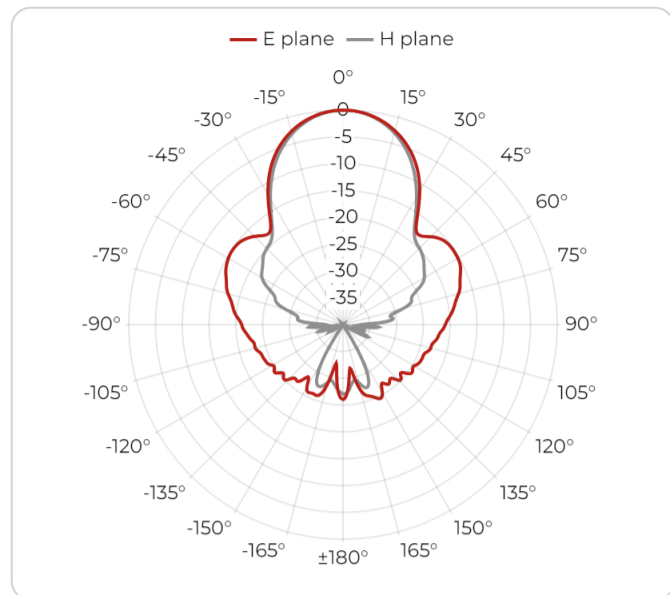

10 GHz

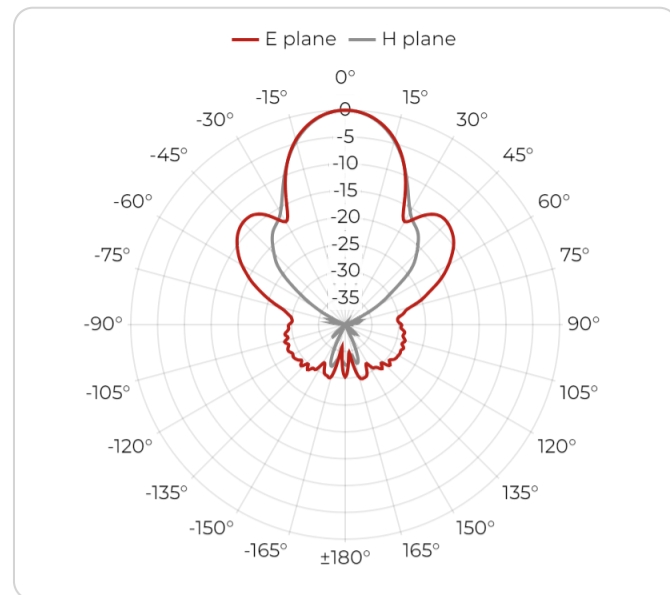

14 GHz

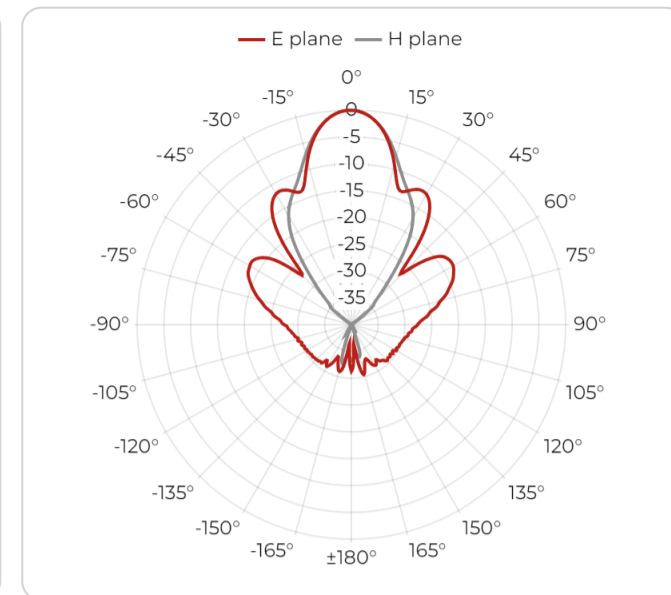

17 GHz

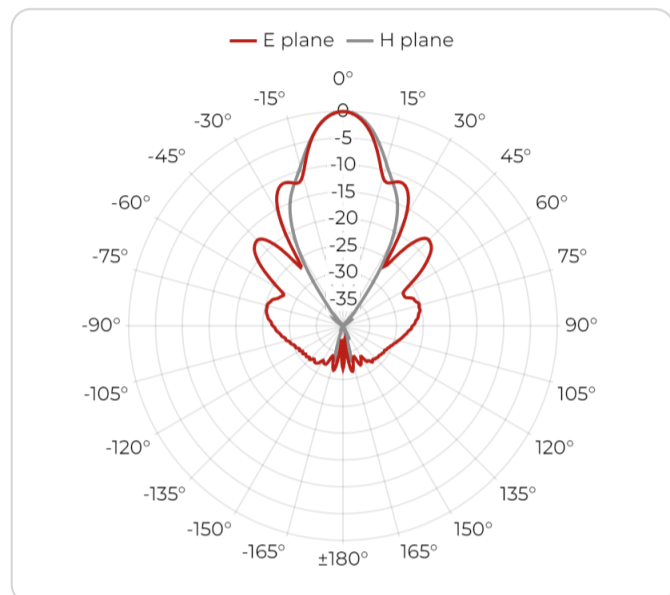

20 GHz

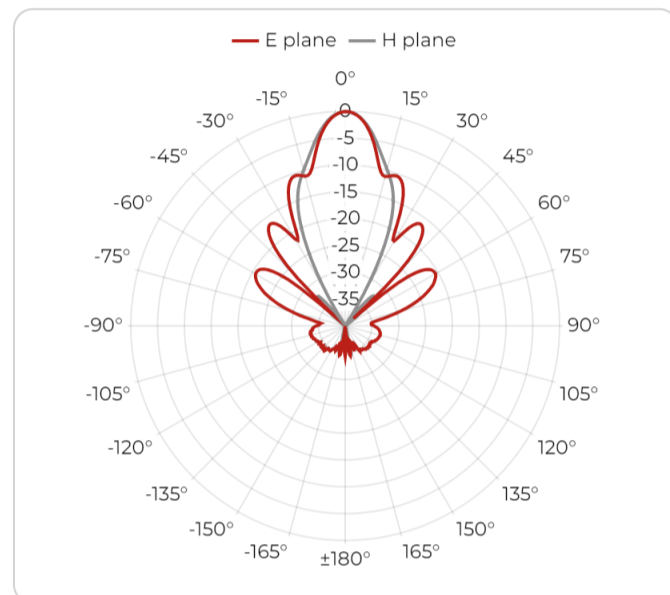

23 GHz

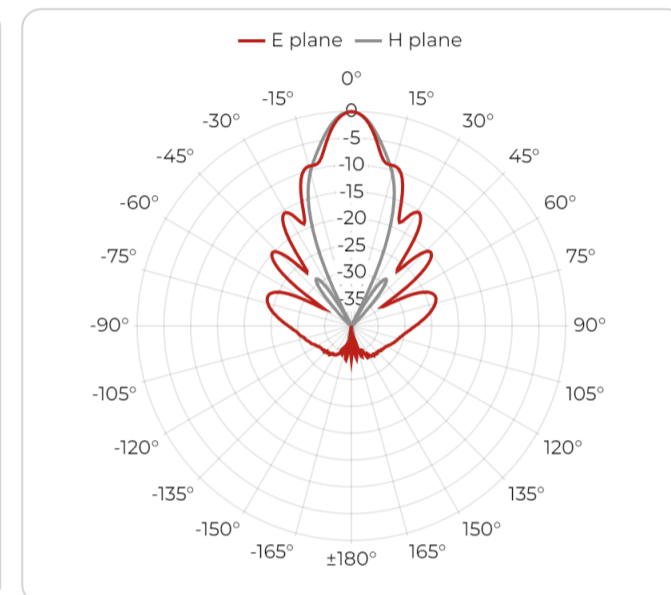

26 GHz

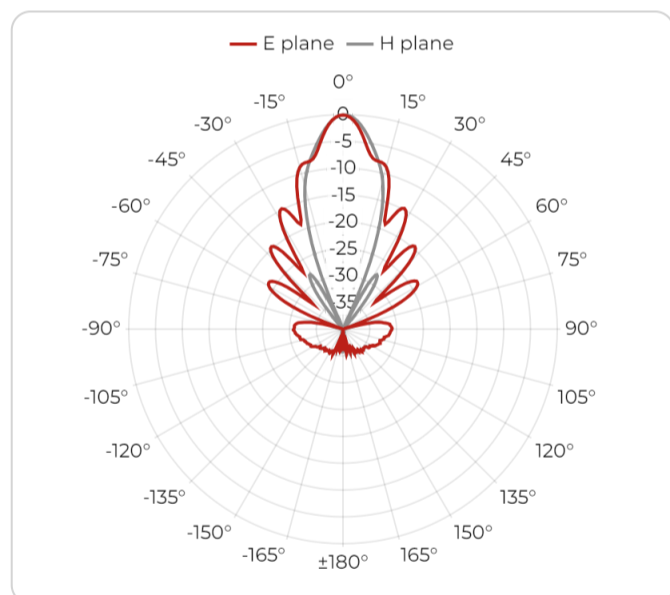

29 GHz

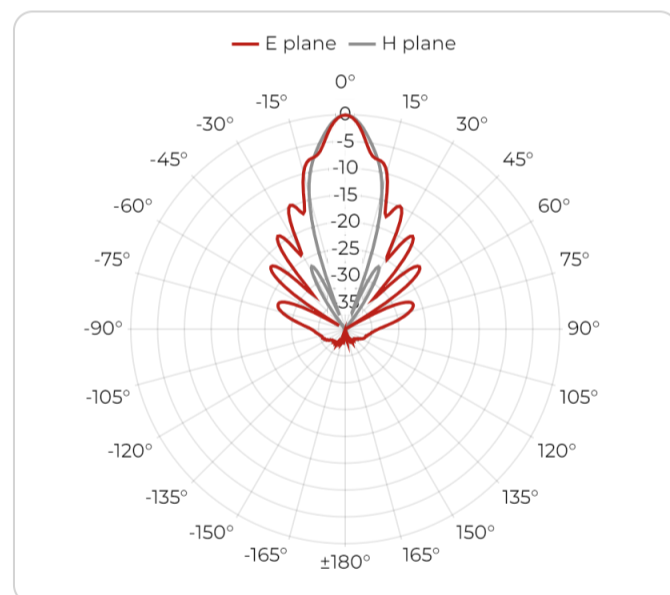

32 GHz

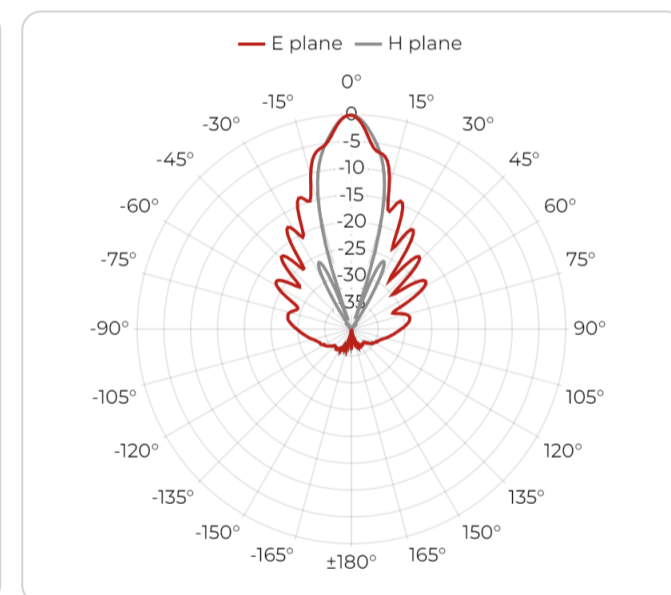

35 GHz

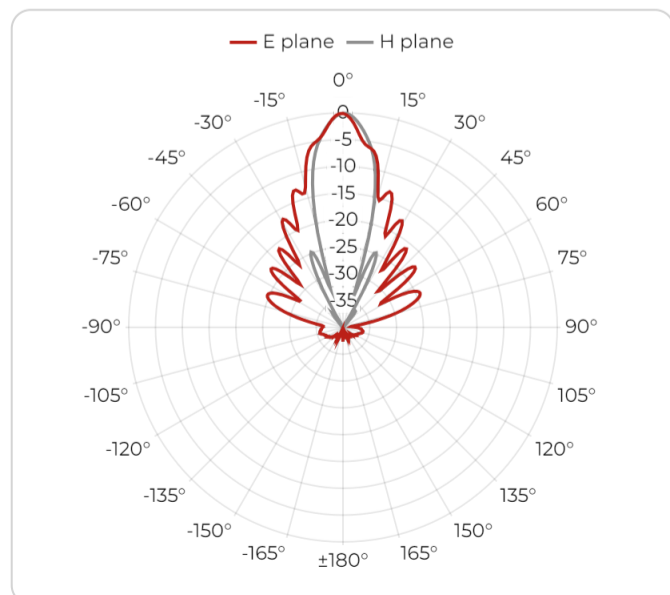

40 GHz

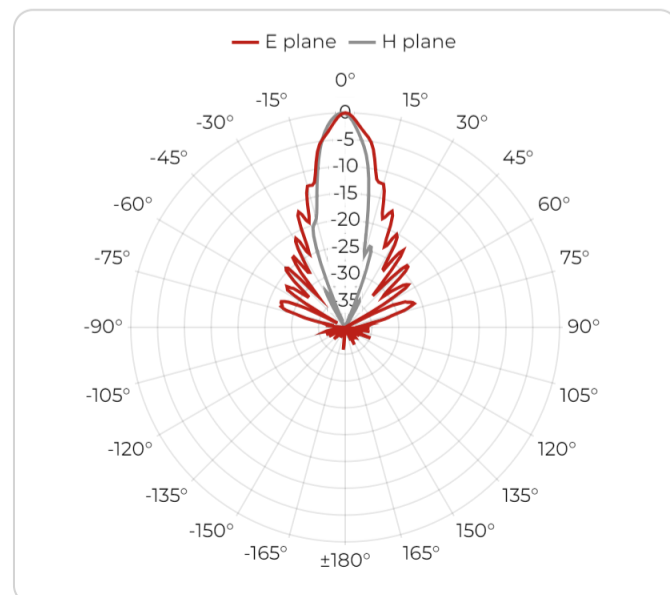

44 GHz

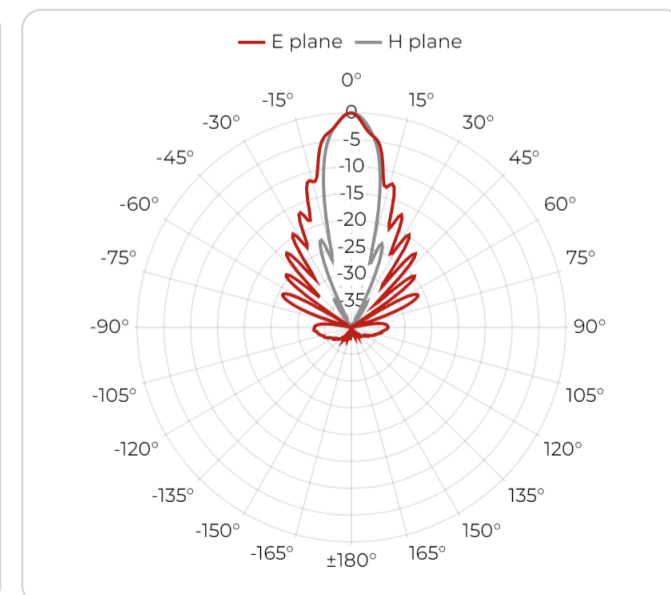

## Packaging and Accessories

### What's in a box

- DRH0844 Antenna
- Antenna specific mount adapter with ¼ inch inner thread
- Factory calibration certificate
- Full calibration report of each antenna
- QR code accessing online portal
- Calibration test dataset (available online)

### Accessories

- Standard mounting flange

### Optional Accessories

- [AHS22-HI Antenna Fixture](#)

### Custom services

- Custom mounting solutions
- Custom calibration data

## Manufacturer Information

### About Datasheet

Product information available also online at  
<https://www.rfspin.com/product/drh0844/>

*Data and specifications subject to change without notice.*

*Datasheet revision 02-2024.*

© RFspin 2024

### 📍 Address

RFspin s.r.o.  
Na Beránce 57/2  
160 00 Prague 6  
Czech Republic

### ✉ E-mail

[info@rfspin.com](mailto:info@rfspin.com)

### 📞 Phone

[+420 245 008 847](tel:+420245008847)